



# INDUSTRIAL LEGS FOR TABLES AND BENCHES



**Table legs made of steel profile 40x80, total dimension 705x600 mm**

- pack of 2 pcs.
- installation set with screws or bolts included

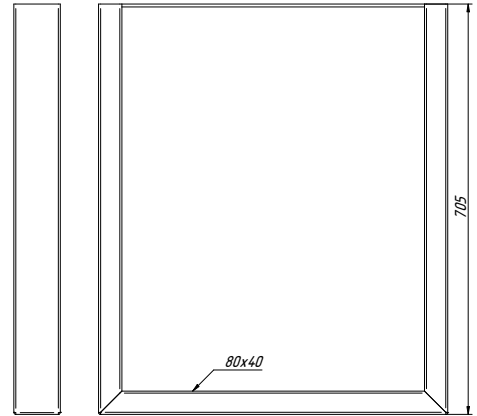
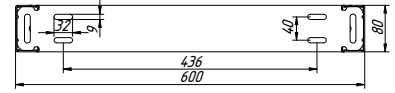
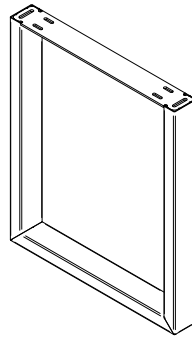

index	colour	type of installation
WH02.2918.01	055	bolts
WH02.2918.01	855	
WH02.2918.01	083	
WH02.2919.01	055	screws
WH02.2919.01	855	
WH02.2919.01	083	

**Bench legs made of steel profile 40x80, total dimension 405x330 mm**

- pack of 2 pcs.
- installation set with screws or bolts included

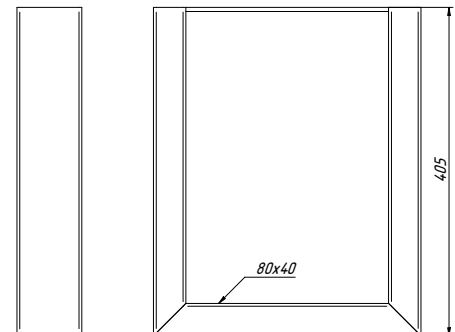
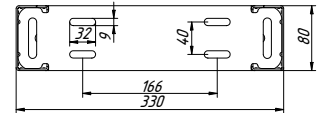
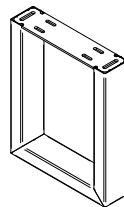

index	colour	type of installation
WH02.2920.01	055	bolts
WH02.2920.01	855	
WH02.2920.01	083	
WH02.2921.01	055	screws
WH02.2921.01	855	
WH02.2921.01	083	

**Bench backrest made of flat bar 60x8**

• pack for 1 pc.

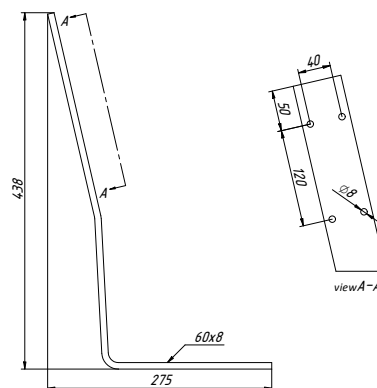
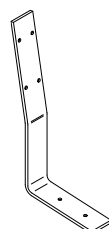
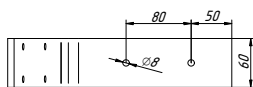
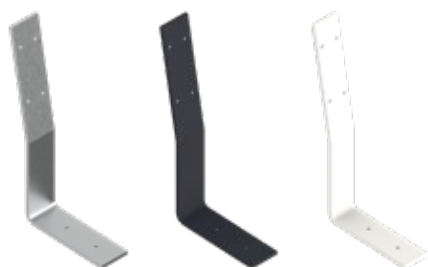

index	colour
WH02.1640.01	083
WH02.1640.01	055
WH02.1640.01	855

**Leg made of flat bar 80x10**

• pack of 2 pcs.

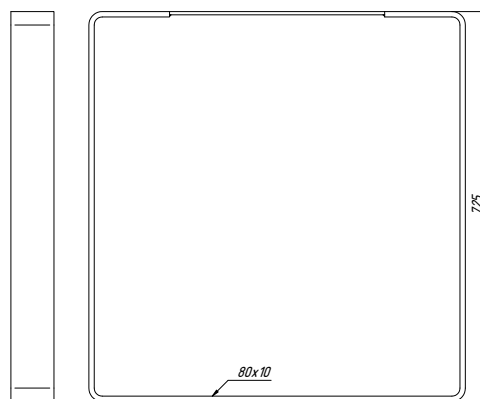
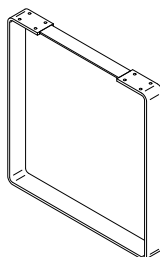
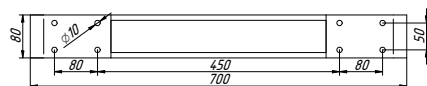
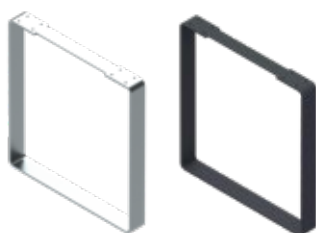

index	colour
WH02.1149.01	083
WH02.2899.01	055
WH02.2899.01	855

**Table leg made of steel profile 100x20**

• pack for 1 pc.  
• installation set with screws included

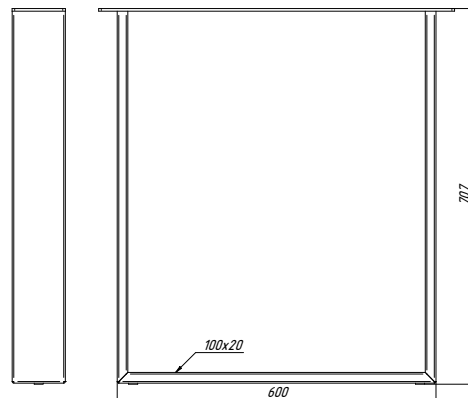
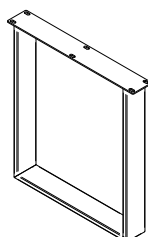
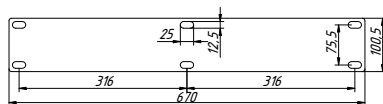
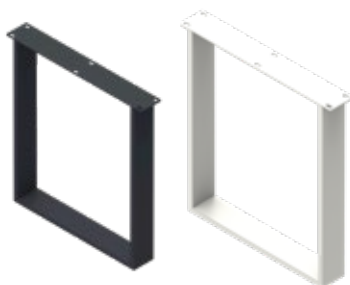

index	colour
WH02.2343.01	055
WH02.2343.01	855

TABLE LEG MADE OF PROFILE 100x20  
WH02.2343.01.055





**Industrial Legs „X” type**

- pack of 2 pcs.
- installation set with screws and regulators included

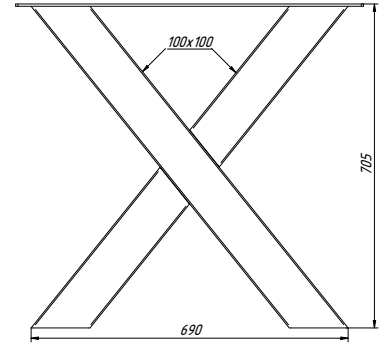
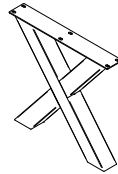
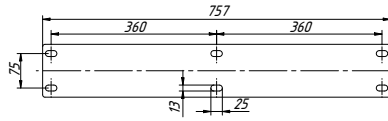

index	colour
WY02.0803.01	055
WY02.0803.01	855

**Industrial double Legs „X” type**

- pack for 1 pc.
- installation set with bolts, screws and regulators included

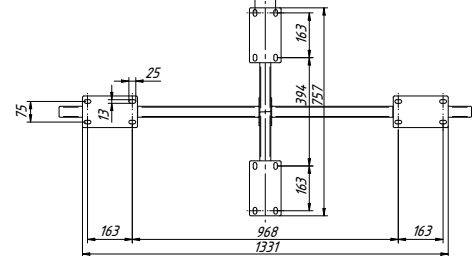
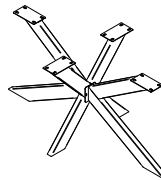
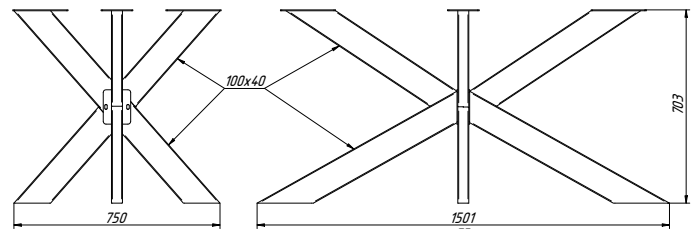
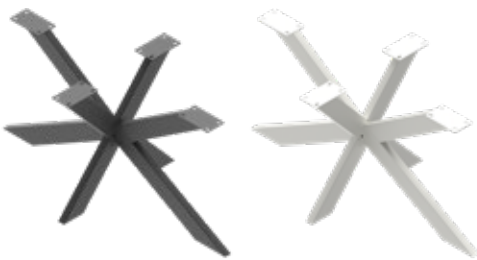

index	colour
WY02.0802.01	055
WY02.0802.01	855

**Industrial Leg „Spider” type**

- pack for 1 pc.
- installation set with bolts, screws and regulators included

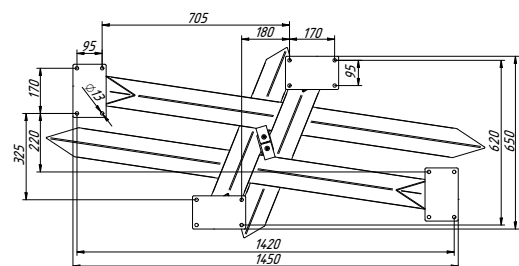
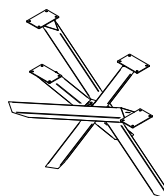
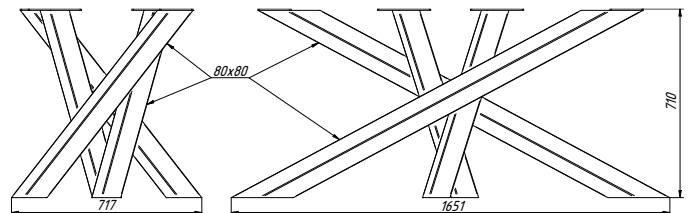
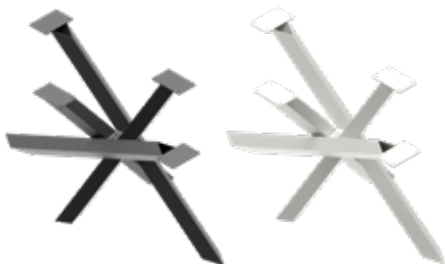

index	colour
WY02.0801.01	055
WY02.0801.01	855

### Industrial Leg „Emden” type

- pack for 1 pc.
- installation set with bolts, screws and regulators included

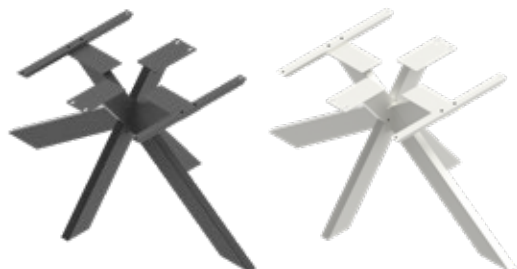

index	colour
WY02.0804.01	055
WY02.0804.01	855

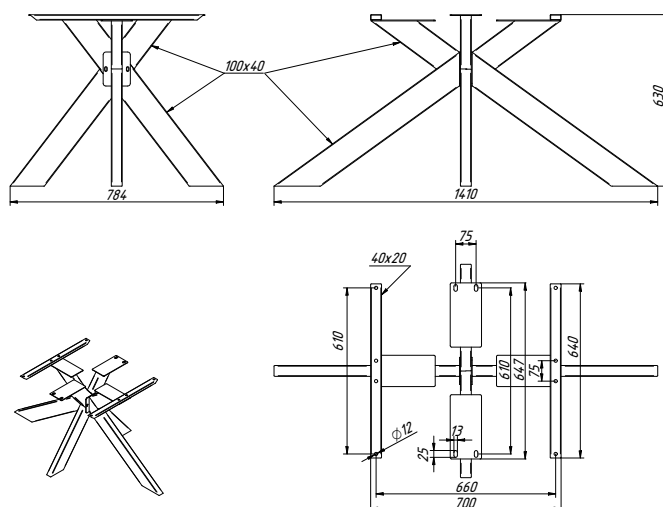

### Industrial Leg „Crab” type

- pack for 4 pcs.
- installation set with screws and regulators included



index	colour
WY02.0805.01	055
WY02.0805.01	855

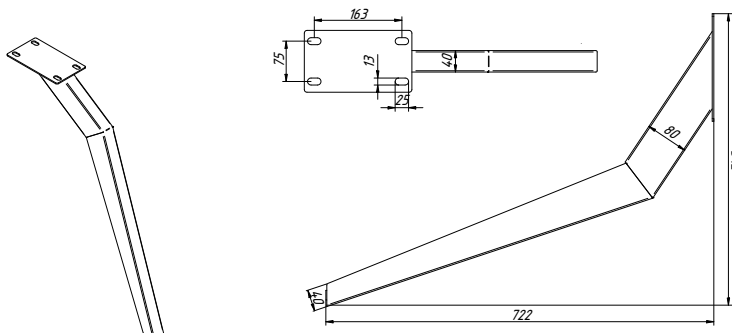

### Small double Leg „X” type

- pack for 1 pc.
- installation set with bolts, screws and regulators included

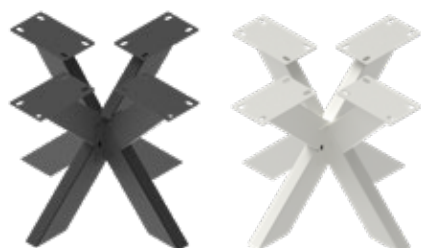

index	colour
WY02.0806.01	055
WY02.0861.01	855

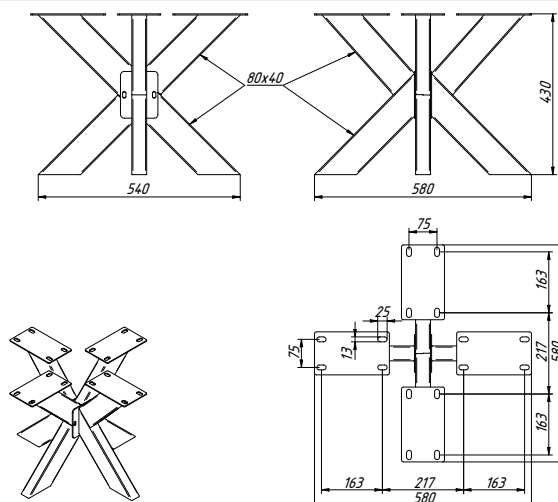

**HEADQUARTERS:**

REJS LLC, 87-500 Rypin, Mlawska Str. 61 Poland  
Export Department: +48 54 234 09 73, www.rejs.eu



RejsRypin



REJS Group



rejs\_en



rejs\_ukraine



rejs\_ru